

KÖŞE MENTEŞELER

CORNER HINGES

311

180° Geçme Menteşe / 180° Corner Hinge

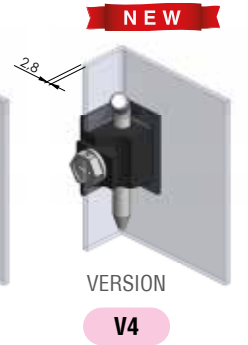
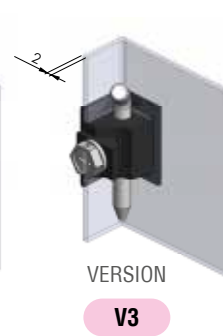
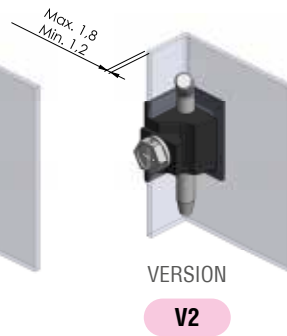
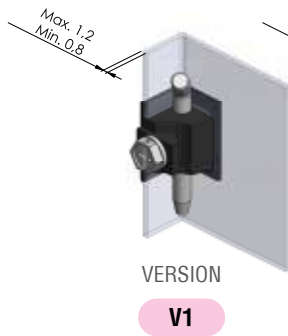
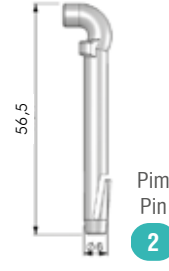
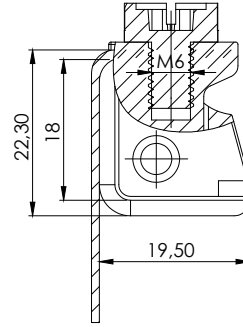
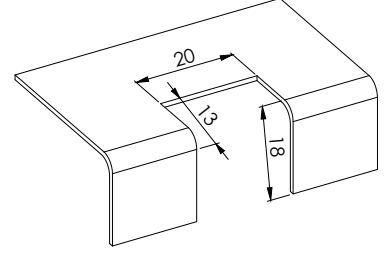
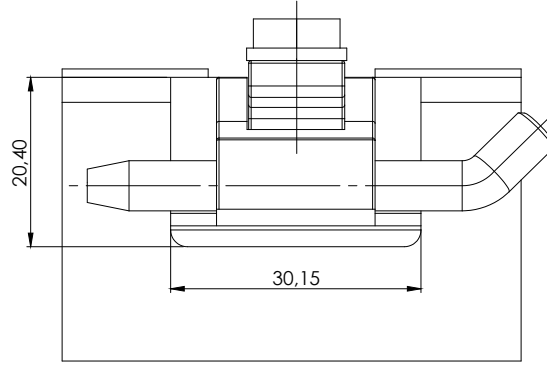

KULLANIM ALANLARI:

Elektrik Panoları, Makine Kapakları, Jeneratörler

APPLICATIONS:

Electric Panels, Machinery Covers, Generators

| MALZEME / MATERIAL | |
|--------------------|--|
| GÖVDE BODY | Zamak Zinc Die |
| PİM PIN | Çelik veya Poliasetal (Delrin) Steel or Polyacetal (Delrin) |

| Kod Code | Version | Yüzey Finishing | Pim Pin |
|-------------|---------|--------------------|------------|
| 311 | V | F | P |

| YÜZEY / FINISHING | CODE | PİM / PIN (P) | CODE |
|--------------------------------------|------|---------------------|------|
| Krom Kaplama / Chrome Plated | 1 | Çelik / Steel | 1 |
| Siyah Toz Boya / Black Powder Coated | 2 | Delrin / Polyacetal | 2 |